

TITLE	B502A	STATION INTERFACE DRIVER
Dwg#	SB502A	Rev 2.00
Date	08-03-10	Sheet 1 of 6
FROTHINGHAM ELECTRONICS CORP		

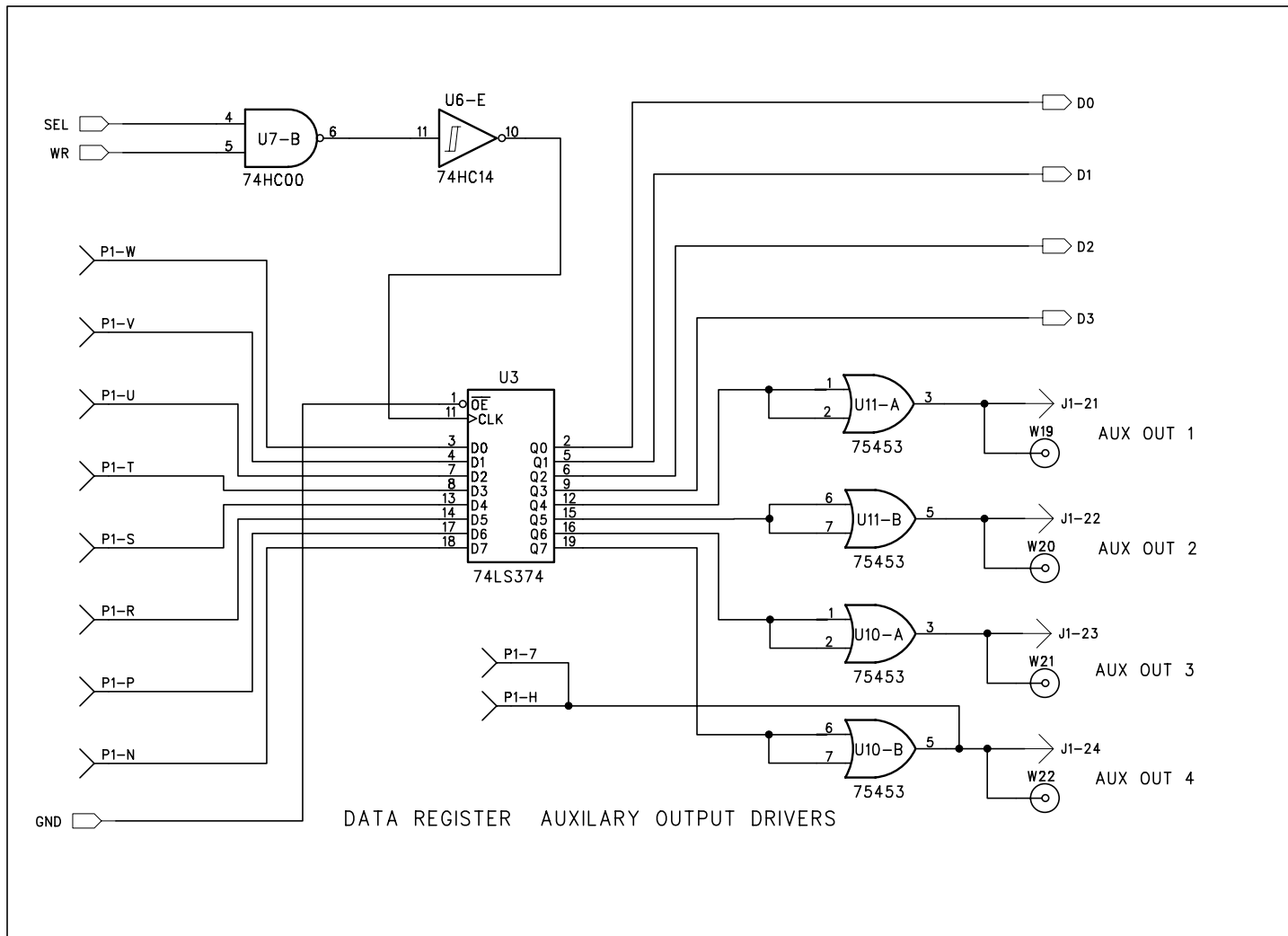

TITLE	B502A		STATION INTERFACE DRIVER		
Dwg#	SB502A	Rev	2.00	Date	08-03-10
		Sheet	2	of	6
FROTHINGHAM ELECTRONICS CORP					

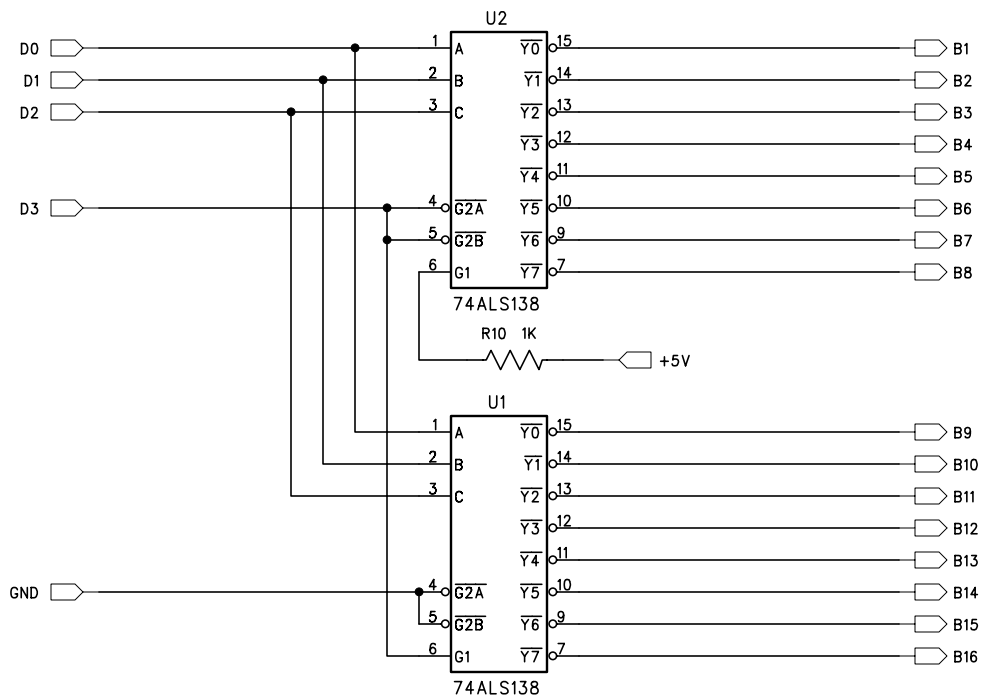

BIN DECODER

TITLE	B502A	STATION INTERFACE DRIVER			
Dwg#	SB502A	Rev 2.00	Date 08-03-10	Sheet 3	of 6 FROTHINGHAM ELECTRONICS CORP

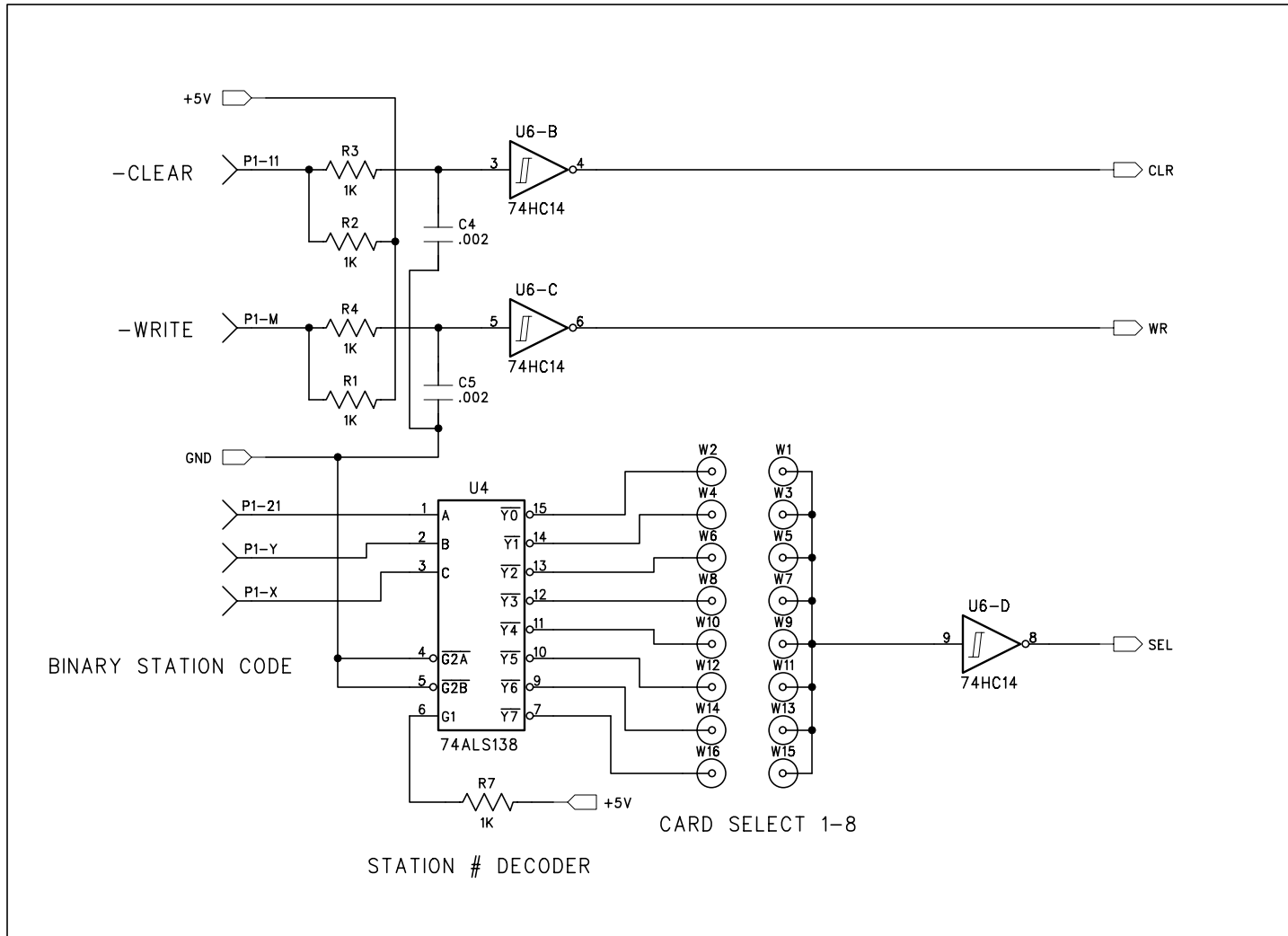

TITLE	B502A	STATION INTERFACE DRIVER				
Dwg#	SB502A	Rev 2.10	Date 08-03-10	Sheet 4	of 6	FROTHINGHAM ELECTRONICS CORP

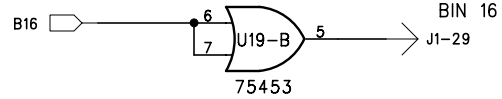
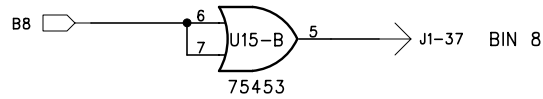
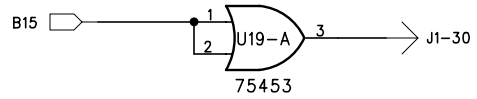
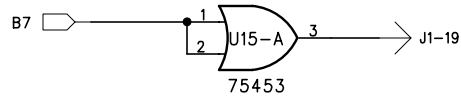
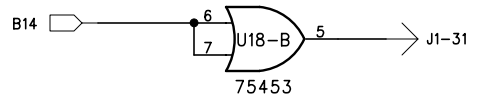
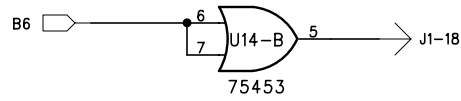
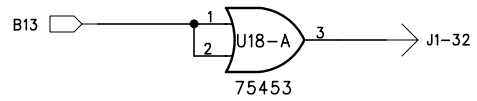
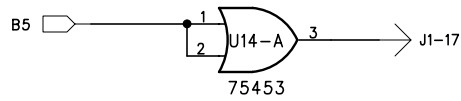
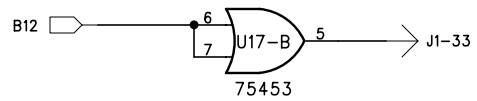
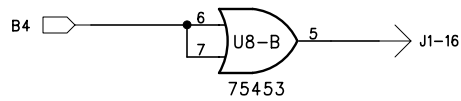
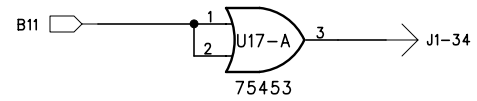
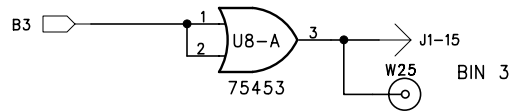
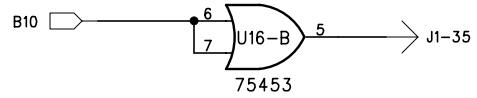
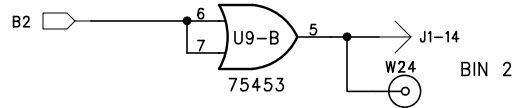
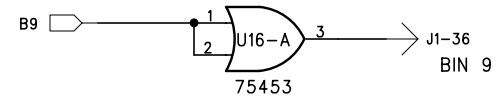
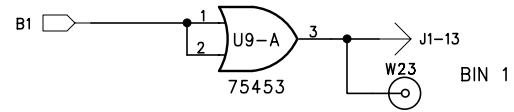

TITLE	B502A STATION INTERFACE DRIVER				
Dwg# SB502A	Rev 2.00	Date 08-03-10	Sheet 5	of 6	FROTHINGHAM ELECTRONICS CORP

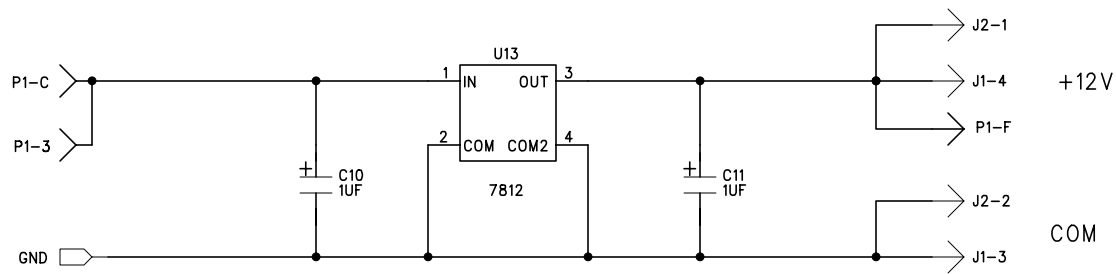

W26  
 W27

J2-3  
 J2-4

J2 IS AN OPTIONAL  
 4 PIN MTE RECEPTACLE  
 HOUSING FOR INTERNAL  
 AUXILIARY CONNECTIONS

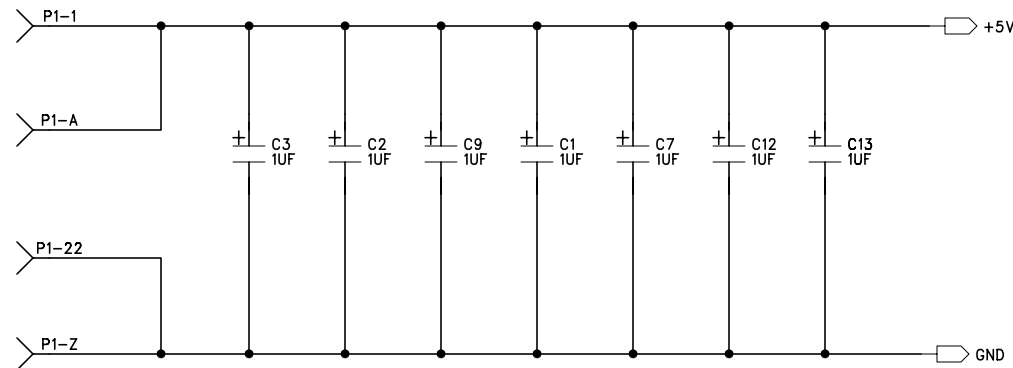

TITLE	B502A STATION INTERFACE DRIVER				
Dwg# SB502A	Rev 2.00	Date 08-03-10	Sheet 6	of 6	FROTHINGHAM ELECTRONICS CORP